



## SERVICE POLICY

In the event of you needing to contact the MX Group Customer Service Department, the following procedure should be followed:-

- 1** Before telephoning the MX Group Customer Service Department you should ensure that you have the model number, power rating, serial number and date of purchase.
- 2** The MX Group Customer Service Department will be able to inform you whether the fault can be rectified by the provision of a replacement part or an on site visit by a Qualified Service Engineer.
- 3** If a service call is booked, you or a representative must be present during the Engineers visit.
- 4** A charge will be made where a call under the terms of the guarantee has been booked and a failure was not product related, or an engineer arrives and is not able to gain access.
- 5** If the product is no longer covered by the Guarantee, a charge will be made for the site visit and for any parts supplied.

**Customer Service Department**

**Telephone: 0844 372 7768 Fax: 0844 372 7767**

**9.00 am - 5.00 pm Monday to Friday**

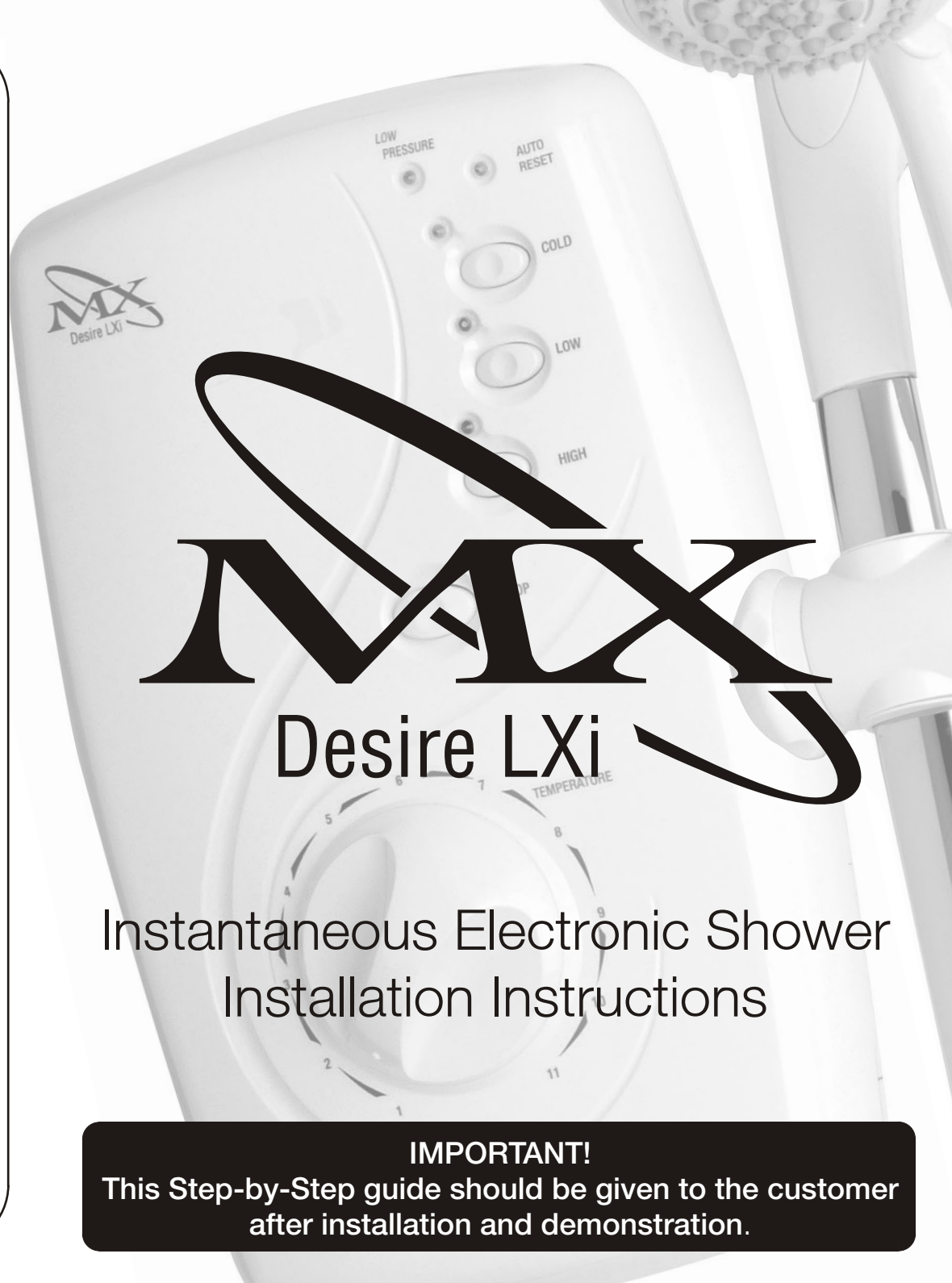

# MX

## Desire LXi

## Instantaneous Electronic Shower Installation Instructions

**IMPORTANT!**  
This Step-by-Step guide should be given to the customer after installation and demonstration.

## SECTION

# 1

## PACKING CONTENTS

- Shower Unit
- Showerhead
- Flexible Hose
- Slider Rail Tube
- Slider Rail Brackets
- Slider Rail Showerhead Holder
- Soap Dish & Collar
- Hose Retaining Ring
- Screw Pack

## IMPORTANT

- 1** Shower Installation must be carried out by a suitably qualified person and conform with IEE Regulations and National Water Council bylaws.
- 2** This shower unit is designed to be connected to a 15mm cold water mains supply.  
**Do not connect to a tank supply unless a suitable booster pump is fitted.**
- 3** To make sure of activating the heating elements, the shower must be connected to a mains water supply with a minimum running pressure of 100kPa (15 lb/sq in) - (1 Bar) at a minimum flow rate of 8 litres per minute. The maximum static pressure must be no greater than 1000kPa (150 lb/sq in) - (10 Bar). (Minimum running pressure must be obtained at 9 litres/minute for 9.5kW and 11 litres/minute for the 10.5kW).
- 4** The shower unit must not be fitted where it may be exposed to frost, for example in an outdoor area.  
**The shower must not be used if suspected of being frozen.**  
Frost damage is not covered by the guarantee.
- 5** Plumbers jointing compound must not be used.  
In instances of difficult joints use P.T.F.E.

Tape. The use of compound invalidates the guarantee.

- 6** All plumbing connections must be completed before making the electrical connections.
- 7** The outlet of your shower acts as a vent and must **NOT** be connected to any form of tap or fitting not recommended by The MX Group.
- 8** Always switch off at the isolating switch when not in use.

## SECTION

# 2

## GENERAL ADVICE TO SHOWER UNIT USERS

The following points will help you to understand how your MX shower unit operates.

The flow rate of water passing through the shower unit determines the water temperature. The lower the flow the warmer the water, the higher the flow the cooler the water.

The temperature produced by the shower unit will vary between seasons on any one setting of the temperature control. This is due to variance in the temperature of the water supply, which becomes cooler in winter than summer.

The stabiliser valve maintains an almost constant shower temperature during mains water pressure changes.

If changes in temperature are experienced in normal use, it is likely to be caused by water pressure falling below the minimum level. Falls in water pressure may be due to water being drawn off at other points within the building.

The shower head must be cleaned regularly to remove scale and debris. If the water becomes hot and you are unable to obtain cooler water, check the spray head for blockage.

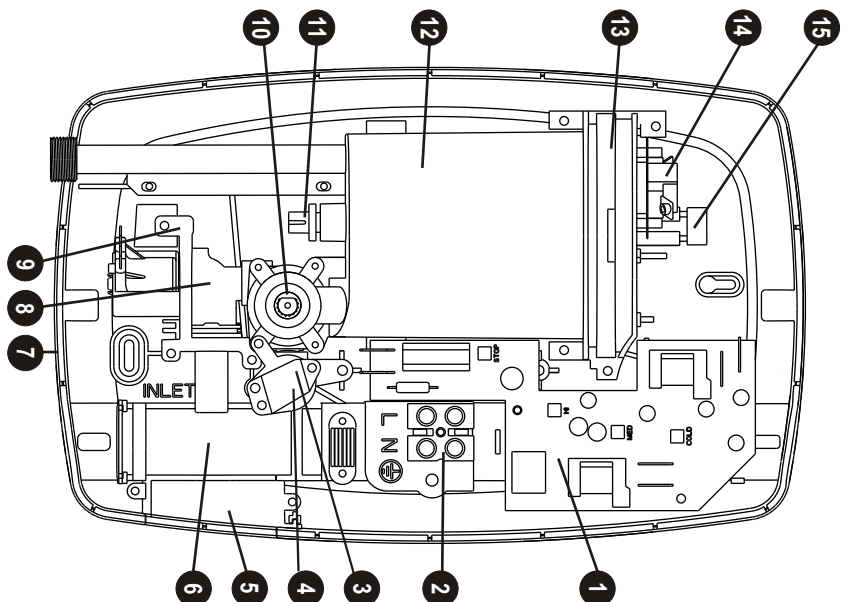

### MX Desire LXi Components

	PART No.
1. Printed Circuit Board	3300001
2. Terminal Block	3250001
3. Alp Switch	3210006
4. Pressure Switch Assembly	A04000015
5. Trim Plate	2021024
6. Speed Fit Fitting	5200002
7. Back Plate Assembly	A08000006
8. Solenoid Valve Assembly	2050013
9. Clamp Solenoid Valve Inlet	2021014
10. Flow Valve Top Assembly	A03000002
11. PRD Assembly	A03000005
12. Oval Plastic Can Assembly	2021012
13. Element Clamp (Oval)	3220004
14. Thermal Cut-Out	
15. Oval Element Assembly	6548540
8.5kW 240v	
Oval Element Assembly	6549547
8.5kW 240v	
Oval Element Assembly	6541052
8.5kW 240v	
16. Cover Assembly	A09000038

This appliance is not intended for use by persons (Including children) with reduced physical, sensory or mental capabilities, or lack of experience and knowledge, unless they have been given supervision or instruction concerning use of the appliance by a person responsible for their safety.

Children should be supervised to ensure that they do not play with the appliance.

### SECTION 3 GENERAL LAYOUT OF A SHOWER INSTALLATION

A TYPICAL INSTANTANEOUS ELECTRIC SHOWER INSTALLATION

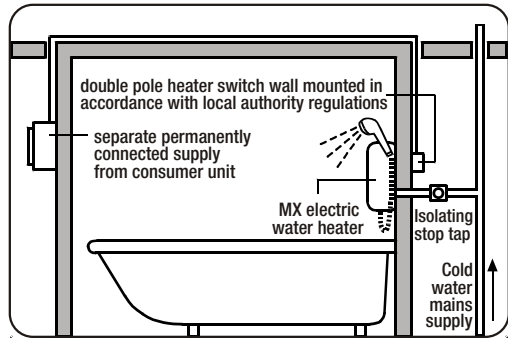

Plan your own installation carefully. Check on the nearest and most readily accessible rising mains water supply, this may be beneath the bath or in the loft, where it feeds the cold water storage tank. Use only the cold rising water main supply. **Do not connect the shower unit to the down service from the tank.**

Avoid connecting the shower unit, if possible, where it will be affected by water drawn off by other appliances, e.g. From the mains feed to the W.C., This may cause a drop in pressure too low for the shower unit to work correctly.

An isolating valve must be fitted into the water supply for servicing purposes.

### SECTION 4 INSTALLATION

Position your shower unit on the wall away from the direct spray of the shower and at about the same height as the shower head position.

The shower unit should be positioned so that the shower head cannot be immersed in the bath or shower tray when hanging down.

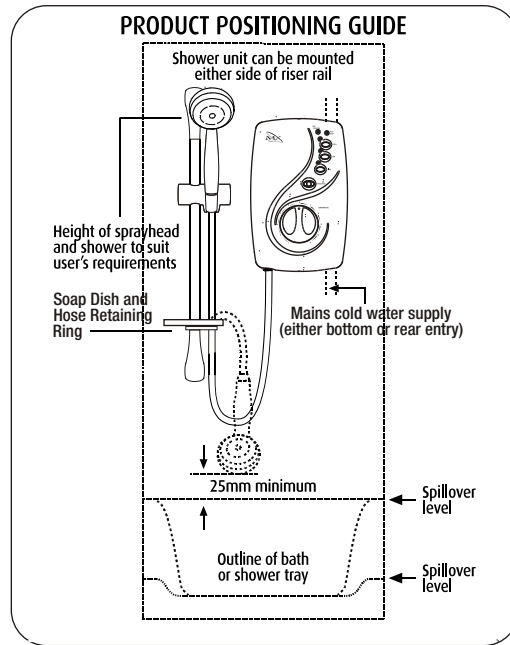

Remove the two screws securing the shower unit cover and remove the cover complete with the control knobs.

Place the shower unit on the wall and mark the location of the fixing screws through the back plate.

Carefully drill the holes as marked using a sharp 5.5mm masonry drill.

Fix the shower unit to the wall using the plugs and screws provided, do not fully tighten at this stage.

**IMPORTANT**

- To comply with National Water Council bylaws a double check valve must be fitted with all flexible shower accessories where it is possible that the shower head may come into contact with used water i.e. In the bath or shower tray.

### SECTION 5 PLUMBING CONNECTION

Plumbing the shower unit must precede wiring.

Turn off the water supply at the isolating stop tap.

Having determined the direction of the inlet water supply: **Top** (falling), **Bottom** (rising), or **Back** inlet. It is necessary to remove the appropriate plastic cross section from the back plate, before commencing with the installation (See diagrams Fig 1 & Fig 2).

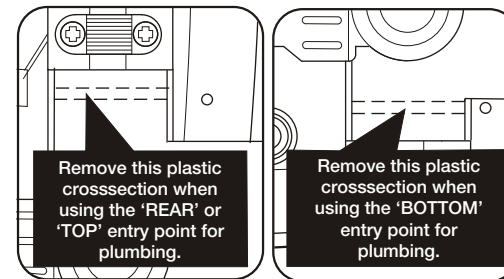

Fig 1.

Fig 2.

The back plate is fitted with removable inserts for **Top** (falling) and **Bottom** (rising) inlet mains water pipework to the shower unit.

We have incorporated into the bottom right-hand side of the back plate an easy removable trim section, to allow easy access when connecting the water supply. **(Please Note!** Remember to replace this trim section before refitting the cover).

Connect the mains water supply to the inlet of the shower unit using a 15mm copper or stainless pipe with a 15mm compression elbow or 15mm push-fit elbow. **Do not use excessive force when making the connection to the unit.**

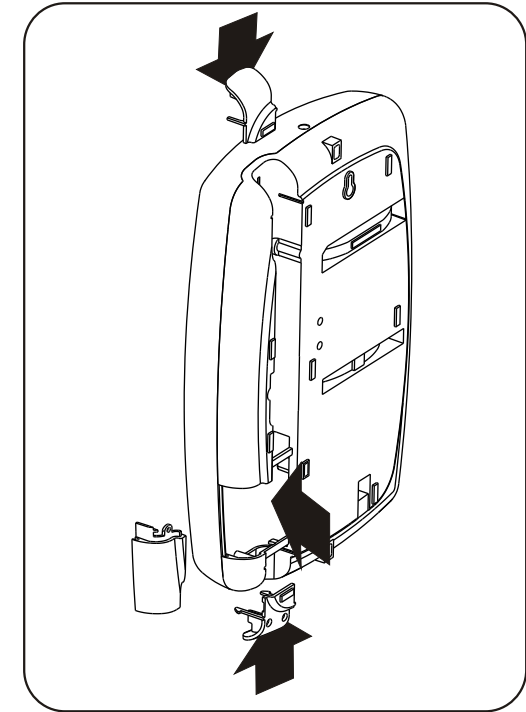

**IMPORTANT**

- Before turning on the water supply to the shower unit the water supply pipe should be flushed out to remove debris.
- After flushing the pipework ensure that the shower unit is positioned squarely on the wall and tighten the screws. Tighten all plumbing connections and check the pipework for leaks.

### SECTION 6 ELECTRICAL CONNECTION Warning! This appliance must be earthed

## ELECTRICAL SPECIFICATIONS

Nominal Power rating at 240v		Nominal Power rating at 230v	
7.5kW	-(32A MCB rating)	6.9kW	-(32A MCB rating)
8.5kW	-(40A MCB rating)	7.8kW	-(40A MCB rating)
9.5kW	-(40A MCB rating)	8.7kW	-(40A MCB rating)
10.5kW	-(45A MCB rating)	9.6kW	-(45A MCB rating)

The shower unit must be permanently connected to the electricity supply, direct from the consumer unit via a double pole linked switch with a minimum contact gap of 3mm. The switch must be readily accessible and clearly identifiable and out of reach of a person using a fixed bath or shower tray, unless the switch is cord operated. The wiring must be connected to the switch without the use of a plug or socket outlet.

The cable size required is determined by the kW rating of the shower and the distance between the shower and the consumer unit. The table below will help you choose the correct cable for your installation, but it will depend upon the precise circumstances of the installation. If you are in any doubt consult an electrician.

KW RATING	NOMINAL AT 240v	MIN RATING OF ISOLATING SWITCH	FUZE RATING	MAX CABLE RUN	
				6mm	10mm
7.0	29.10amps	30 amps	30 amps	29m	48m
7.5	31.25amps	40 amps	40 amps	27m	44m
8.0	33.33amps	40 amps	40 amps	25m	42m
8.5	35.41amps	40 amps	40 amps	23m	38m
9.5	39.58amps	40 amps	40 amps	21m	32m
10.5	43.75amps	45 amps	45 amps	18m	30m

The incoming cable should be hidden.

Connect the live cable to the terminal marked **L**.

Connect the neutral cable to the terminal marked **N**.

Connect the earth cable to the terminal marked **E** on the back plate.

### IMPORTANT

- Ensure that the terminal block screws are fully tightened and that no cable insulation is trapped under screws,
- Ensure the cable clamp is used to secure the cable.

● The earth continuity conductor of the electrical installation must be effectively connected to all exposed metal parts of other appliances and services in the room in which the shower unit is installed to confirm with IEE regulations.

## SECTION

# 7

## FITTING THE COVER INTO POSITION

**NOTE:** It is necessary to align the 'D' flat on the reverse side of the Temperature Knob with its opposite control spindle before the cover is located.

Secure the cover with the two fixing screws provided.

### IMPORTANT

● Turn the flow control knob anti-clockwise until the valve is fully open before switching on the unit. This will ensure a fast fill up of the unit when the shower is first switched on.

Switch on the power to the shower unit at the consumer unit and the double pole switch.

Remove the shower head from the flexible hose and point to waste.

Press the uppermost **COLD** power selector button, this action will also activate the internal solenoid valve turning the water On.

Let the water flow through the shower unit to release any air which may be in the system and fill the shower unit with water.

### IMPORTANT

● The shower unit must be full of water before heat settings are used.

Switch the shower unit OFF by pressing the **STOP** button.

The water will continue flow for a few seconds when the **STOP** button is pushed. This hot water flushing out program is called '**Phased Shutdown**' ensuring that anyone stepping into the shower immediately after use does not have an unpleasantly hot start to their shower.

Re-fit the shower head to the flexible hose.

Your shower is now ready to use. We recommend that you allow your shower to reach a stable temperature before you commence showering.

## SECTION

# 8

## RISER RAIL FITTING INSTRUCTIONS

### TIPS

- A piece of insulating or masking tape applied to the wall before marking out the Fixing holes will help stop the drill from wandering, particularly on tiled surfaces. When working near a basin or bath, insert the plug in the waste fitting so that small parts cannot be lost.
- Take care not to drop accessories or tools into basin or bath.

### CAUTION

- Check there are no hidden cables or pipes before drilling holes for wall plugs. Exercise great care when using power tools near water. The use of a residual current device (RCD) is recommended.

1. Fit the wall brackets onto the ends of the rail and establish height of riser rail to suit users requirements.
2. Remove covers from the wall brackets.
3. Hold the rail assembly in the selected position against the wall, ensure that the

brackets are vertically aligned, and mark the wall for upper and lower screw fixings.

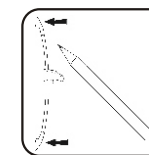
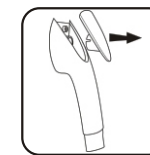
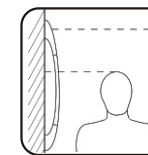

4. Drill and plug the wall.

5. Remove the lower bracket from the rail and fit the adjustable slider, hose retaining ring and soap dish onto the rail.

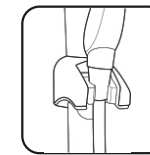

6. Replace the lower bracket and fix the assembly to the wall.

7. Replace the covers onto both brackets.

**Note:** The adjustable slider grips the conical nut on the shower hose.

## SECTION

# 9

## COMMISSIONING THE SHOWER

1. Make sure that the electrical supply has been isolated at the double pole isolating switch.
2. Turn the bottom temperature control knob anti-clockwise to the full cold position.
3. Ensuring the water supply is fully on at the mains stop cock and isolating service valve (if fitted), check that water is not leaking from the bottom of the case.

4. Switch on the electrical supply at the double pole switch. The **'Power'** neon indicator will light.

5. Press the uppermost **COLD** power selector button, this action will also activate the internal solenoid valve turning the water On. A neon indicator adjacent to the button will illuminate to confirm selection.

6. Check that water flows freely from the shower within a few seconds. The water from the showerhead will be at full force and at a cool temperature.

7. Rotate the bottom temperature control knob slowly clockwise fully. This will gradually reduce the flow with the water temperature remaining cool.

8. Return the knob anti-clockwise to maximum flow.

9. Now press the middle power selector button to the **'Low'** setting. Allow a few seconds for the warmer temperature to reach the showerhead - this shows that the **'Low'** power setting is operating correctly. Again, a neon indicator adjacent to the button will illuminate to confirm selection.

10. Now press the bottom power selector button to the **'High'** setting. With neon indicator confirming selection. The temperature at the showerhead will rise further - this shows that the full power setting is operating correctly.

11. Turn the bottom temperature control knob clockwise for hotter water and anti-clockwise for cooler water. Allow a few seconds between selections - for the temperature change to reach the showerhead.

**NOTE. When the temperature is changed the flow rate alters.**

12. Push the **STOP** button to stop the flow.

13. The water will continue flow for a few seconds when the **STOP** button is pushed. This hot water flushing out program is called **'Phased Shutdown'** ensuring that anyone stepping into the shower immediately after use does not have a an unpleasantly hot start to their shower.

14. Switch of pull-cord or wall mounted switch.

## SECTION 10 OPERATING THE SHOWER

1. Switch on pull-cord or wall mounted switch. The **'Power'** neon will illuminate indicating the switch is on.
2. Select your power setting using one of the three push button dual purpose controls. Which when operated also automatically activates instant water flow.

The shower has three positions **'Cold'**, **'Low'** power and **'High'** power.

**'Cold'** setting:

Adjustment of the flow control on this setting will only alter the flow of water not the water temperature.

**'Low'** setting:

This is the low power setting for economy during warmer months or when a cool shower is required. Temperature adjustment is via the bottom temperature control.

**'High'** setting:

This is the full power setting. Temperature adjustment is via the bottom temperature control.

**Note: Neon indicators adjacent to the buttons will illuminate to confirm selection.**

3. Wait a few seconds for the warmer water to reach the handset.

4. If necessary turn bottom 'Temperature' control knob slowly to obtain desired showering temperature. Again, waiting a few seconds after each adjustment in temperature to reach the handset.

Note:

**To adjust the shower temperature.**

The water temperature is altered by increasing or decreasing the flow rate of water through the shower unit via the temperature control.

**To increase the shower temperature**

Turn the temperature control knob clockwise, this will decrease the flow of water and increase the shower temperature.

**To decrease the shower temperature**

Turn the temperature control knob anti-clockwise, this will increase the flow of water and decrease the shower temperature.

5. To turn off the shower unit press the **STOP** button.

6. Remember! Water will continue flow for a few seconds whilst the programmed **'Phased Shutdown'** operates.

7. A small amount of water will be retained in the showerhead after the shower has been turned off. This may drain over a few minutes.

8. Switch of pull-cord or wall mounted switch.

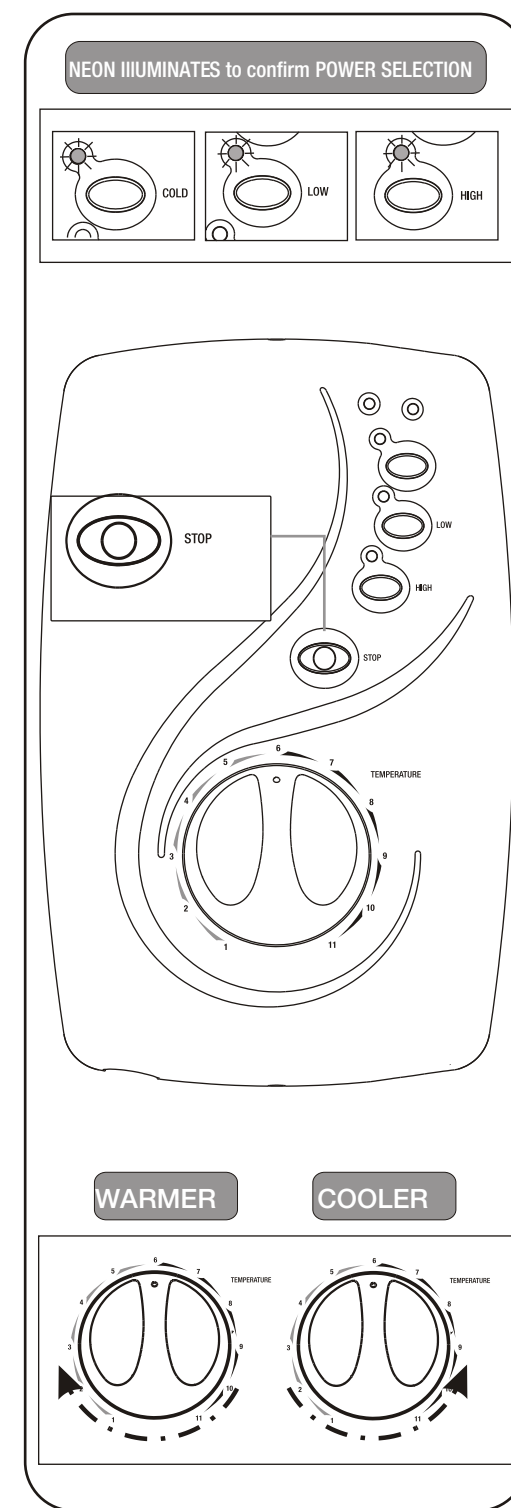

# SECTION 11

## OPERATING FEATURES

### Auto Reset Neon Indicator

The Auto Reset Neon Indicator will be illuminated during normal operation if an overheat temperature is sensed, power to the element will be cut off, water will continue to flow until the unit has cooled sufficiently. Power to the elements will be automatically restored.

If the Auto Reset Neon Indicator persistently functions, ensure that the showerhead is free from scale and debris which will increase the flow of water through the unit.

### Low Pressure Neon Indicator

The low-pressure indicator will be illuminated during normal operation if there is a drop in mains water pressure too low to operate the shower unit. Also turn the flow control knob anti-clockwise to increase the flow of water through the unit.

### Phased Shutdown

The Phased Shutdown ensures that water will continue flow for a few seconds when the STOP button is pushed. This hot water flushing out program ensures that anyone stepping into the shower immediately after use does not have a an unpleasantly hot start to their shower. This process will also increase the life expectance of the unit in hard water areas reducing lime scale build up.

# SECTION 12

## SHOWERHEAD CLEANING INSTRUCTIONS

The showerhead should be cleaned periodically to remove limescale or debris which will reduce the performance of the shower. The frequency of cleaning will vary according to local water quality.

### PERIODICAL MAINTENANCE



1. To break away scale deposits on a daily basis simply rub your thumb over the surface whilst the shower is running.

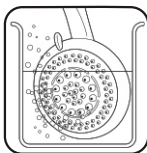

2. If scale deposits are stubborn, soak the showerhead in a proprietary limescale remover and rinse thoroughly before use.

## ATTENTION!

**DO NOT OPERATE THE SHOWER UNIT IF THE SPRAYHEAD OR HOSE BECOMES DAMAGED.**

**THE SHOWER IS DESIGNED AND APPROVED TO EN-60335 WITH THE HANDSET PROVIDED. UNDER NO CIRCUMSTANCES MUST ANY HANDSET THAT IS NOT APPROVED BY THE MANUFACTURER BE USED WITH THIS PRODUCT.**



## GUARANTEE

The MX Group guarantee this product for a period of two years, from date of purchase, against mechanical and electrical defects arising from faulty materials or from poor workmanship, providing the product has been installed by a competent person in accordance with the fitting instructions.

The MX Group undertake to repair or replace, at their discretion, without charge, provided the product has been properly maintained and operated in accordance with the operating instructions. Any component found to be defective during this period, as the result of misuse or damage, or the effects of scaling, will not be covered by this guarantee.

This product must not be modified, repaired or taken apart except by a person authorised by The MX Group.

This Guarantee is only valid within the United Kingdom and does not cover product used commercially.

This Guarantee does not affect your statutory rights.

The MX Group  
Alpha Close, Delta Drive,  
Tewkesbury Industrial Estate,  
Tewkesbury, Glos. GL20 8JF  
Telephone: 01684 293311  
Fax: 01684 293900